

LINEA CR

PERFILES PARA USOS DIVERSOS

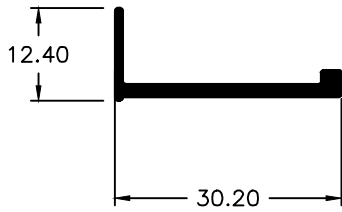



CR-001
Peso: 188 Gr./Mt.

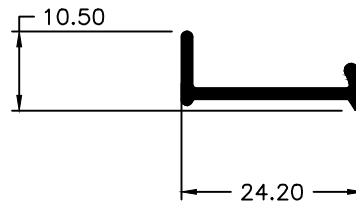

CR-002
Peso: 150 Gr./Mt.

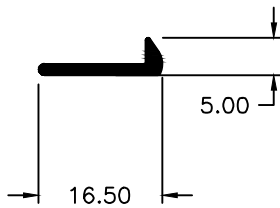

CR-003
Peso: 81 Gr./Mt.

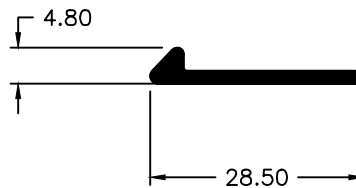

CR-004
Peso: 152 Gr./Mt.

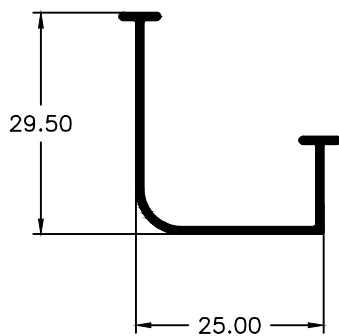

CR-005
Peso: 195 Gr./Mt.

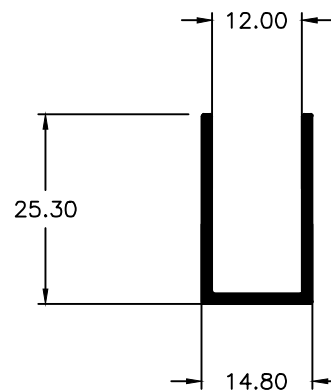

CR-006
Peso: 237 Gr./Mt.

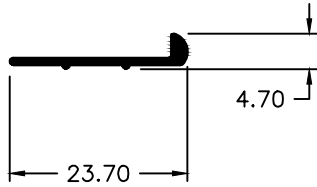

CR-007
Peso: 81 Gr./Mt.

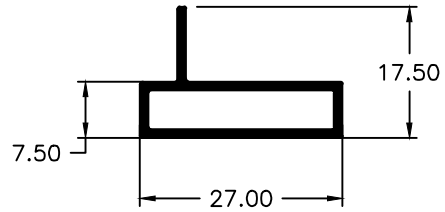

CR-008
Peso: 235 Gr./Mt.

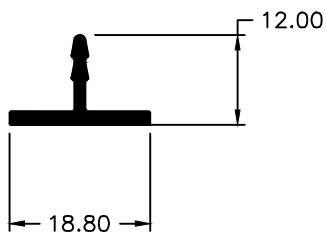

CR-009
Peso: 138 Gr./Mt.

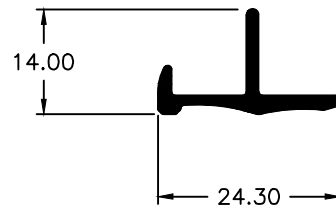

CR-010
Peso: 185 Gr./Mt.

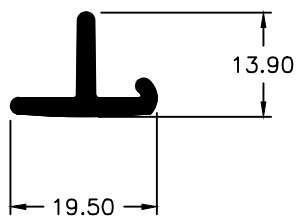

CR-011
Peso: 210 Gr./Mt.

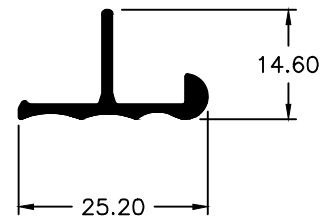

CR-012
Peso: 178 Gr./Mt.

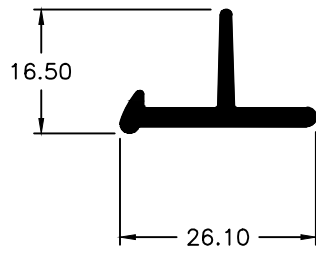

CR-013
Peso: 250 Gr./Mt.

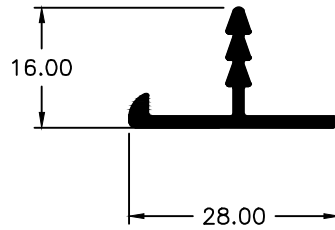

CR-014
Peso: 210 Gr./Mt.

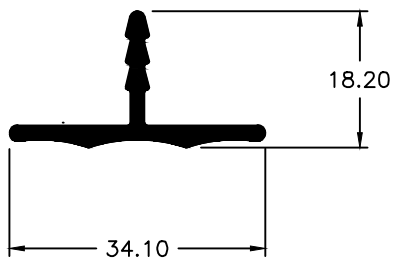

CR-015
Peso: 297 Gr./Mt.

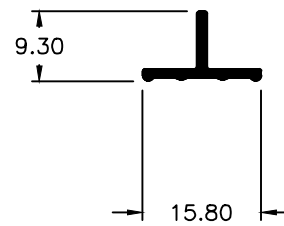

CR-016
Peso: 85 Gr./Mt.

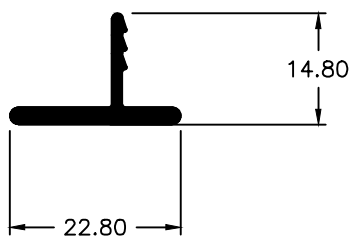

CR-017
Peso: 192 Gr./Mt.

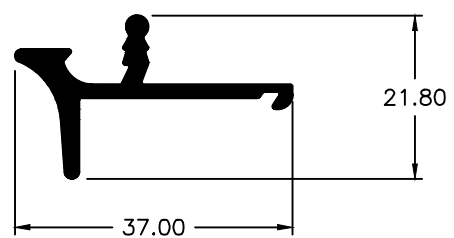

CR-018
Peso: 360 Gr./Mt.

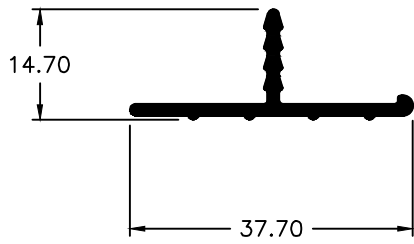

CR-019
Peso: 237 Gr./Mt.

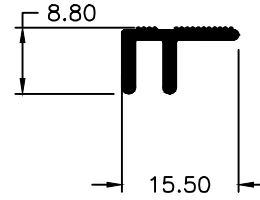

CR-020
Peso: 126 Gr./Mt.

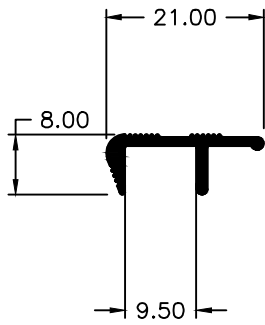

CR-021
Peso: 130 Gr./Mt.

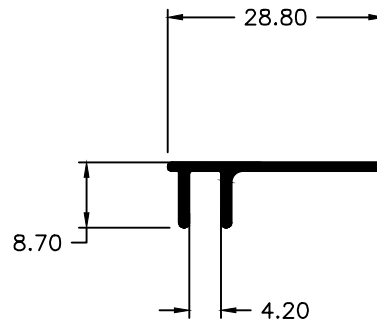

CR-022
Peso: 150 Gr./Mt.

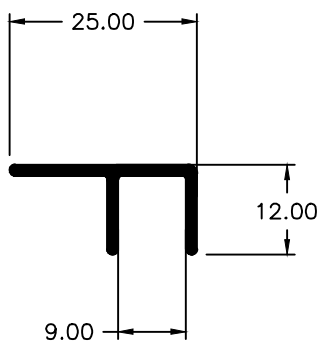

CR-023
Peso: 185 Gr./Mt.

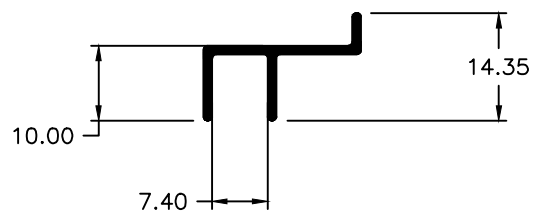

CR-024
Peso: 133 Gr./Mt.

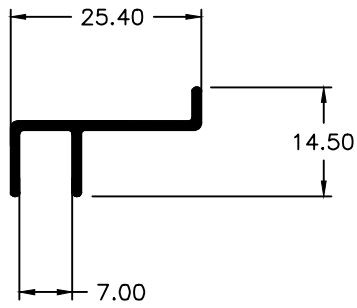

CR-025
Peso: 153 Gr./Mt.

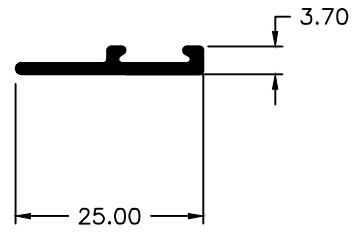

CR-026
Peso: 125 Gr./Mt.

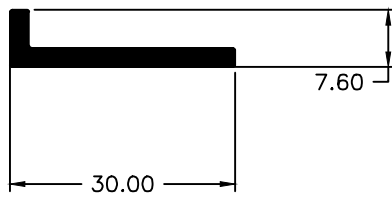

CR-027
Peso: 240 Gr./Mt.

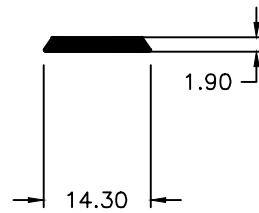

CR-028
Peso: 70 Gr./Mt.

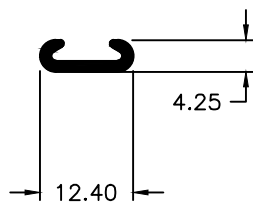

CR-029
Peso: 074 Gr./Mt.

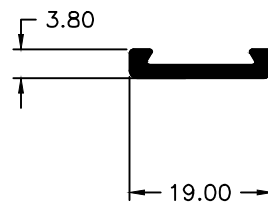

CR-030
Peso: 120 Gr./Mt.

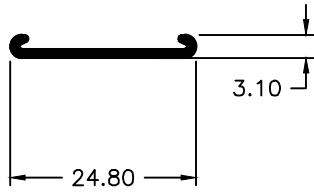

CR-031
Peso: 98 Gr./Mt.

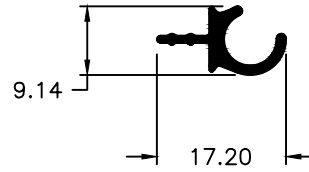

CR-032
Peso: 112 Gr./Mt.

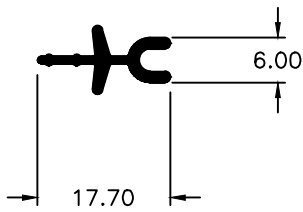

CR-033
Peso: 118 Gr./Mt.

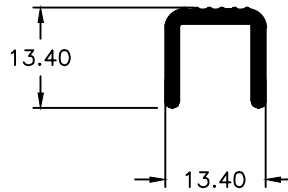

CR-034
Peso: 177 Gr./Mt.

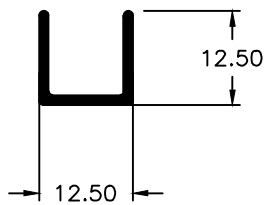

CR-035
Peso: 120 Gr./Mt.

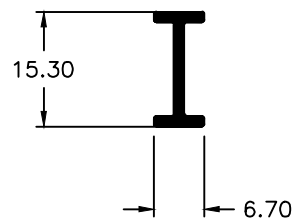

CR-036
Peso: 98 Gr./Mt.

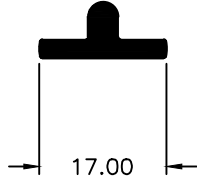

CR-037
Peso: 165 Gr./Mt.

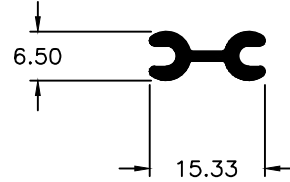

CR-038
Peso: 127 Gr./Mt.

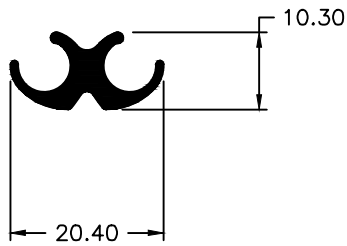

CR-039
Peso: 205 Gr./Mt.

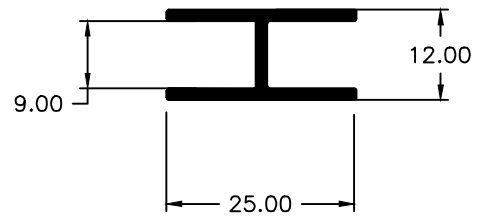

CR-040
Peso: 241 Gr./Mt.

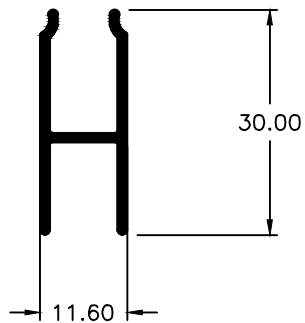

CR-041
Peso: 243 Gr./Mt.

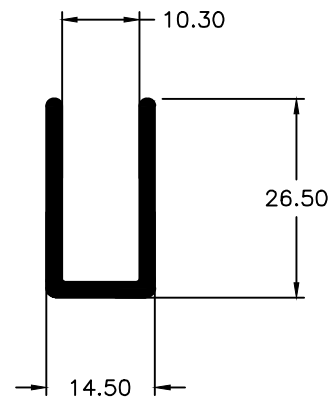

CR-042
Peso: 355 Gr./Mt.

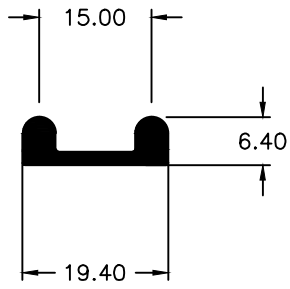

CR-043
Peso: 195 Gr./Mt.

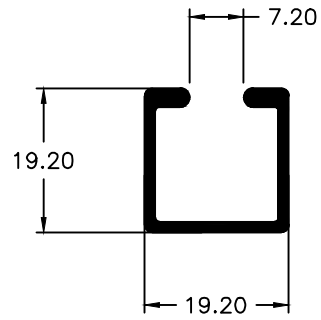

CR-044
Peso: 265 Gr./Mt.

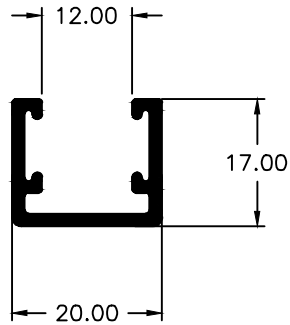

CR-045
Peso: 285 Gr./Mt.

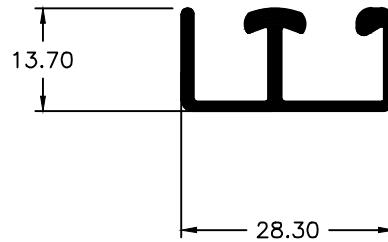

CR-046
Peso: 324 Gr./Mt.

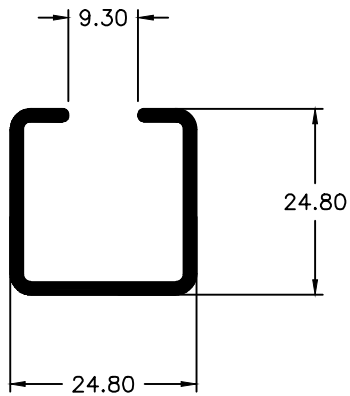

CR-047
Peso: 365 Gr./Mt.

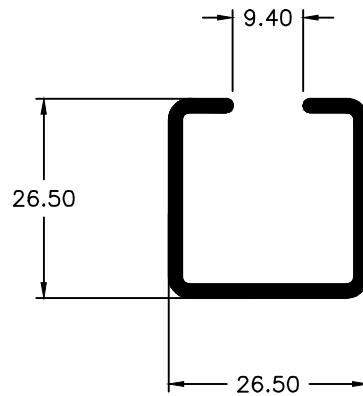

CR-048
Peso: 420 Gr./Mt.

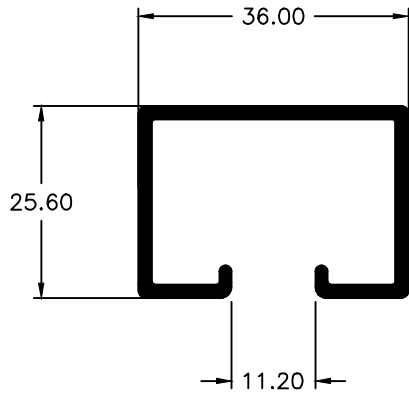

CR-049
Peso: 525 Gr./Mt.

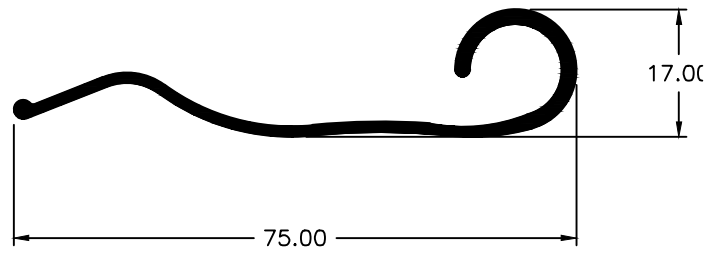

CR-050
Peso: 455 Gr./Mt.

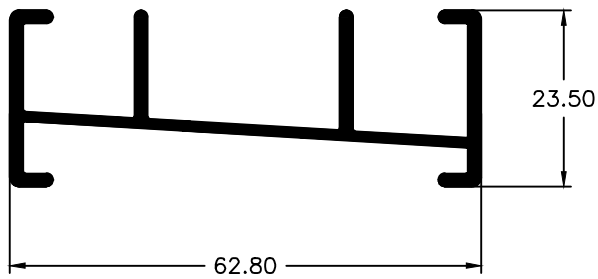

CR-051
Peso: 640 Gr./Mt.

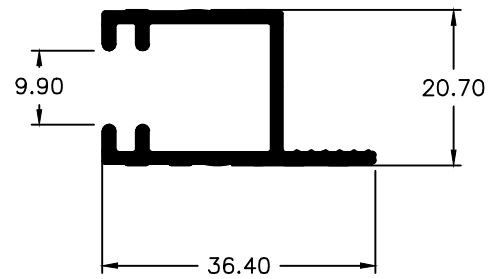

CR-052
Peso: 415 Gr./Mt.

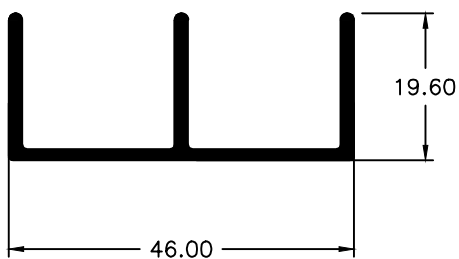

CR-053
Peso: 450 Gr./Mt.

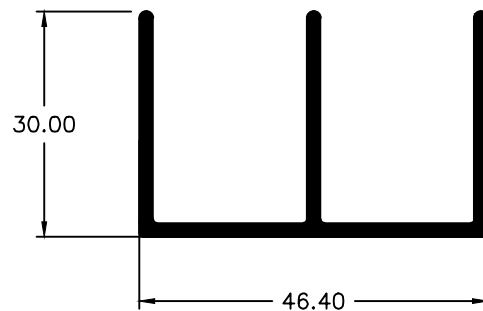

CR-054
Peso: 635 Gr./Mt.

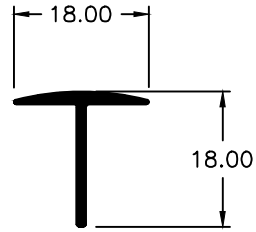

CR-055
Peso: 120 Gr./Mt.

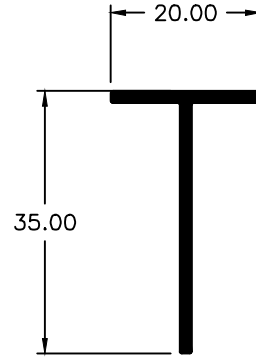

CR-056
Peso: 230 Gr./Mt.

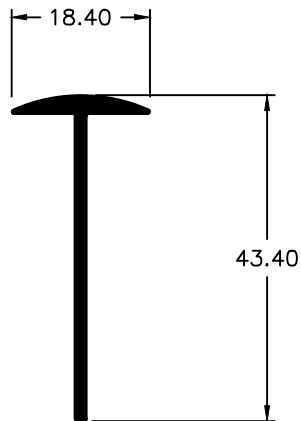

CR-057
Peso: 270 Gr./Mt.

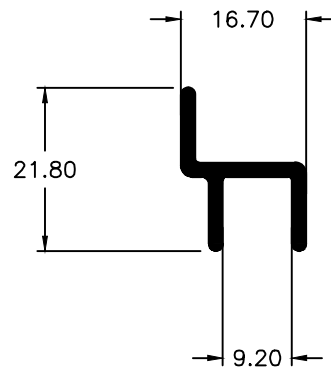

CR-058
Peso: 234 Gr./Mt.

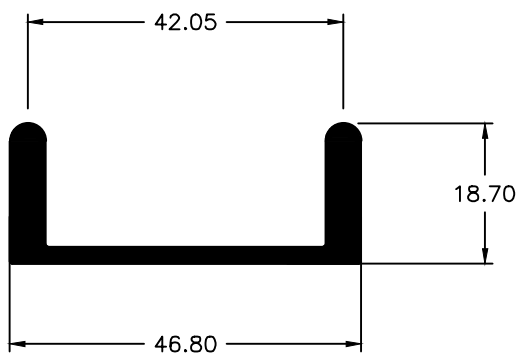

CR-059
Peso: 700 Gr./Mt.

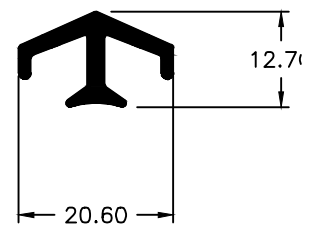

CR-060
Peso: 232 Gr./Mt.

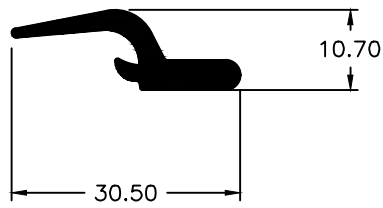

CR-061
Peso: 294 Gr./Mt.

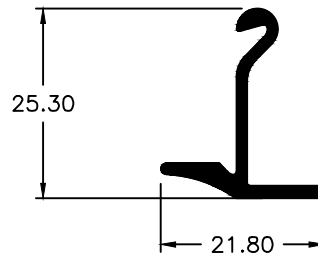

CR-062
Peso: 230 Gr./Mt.

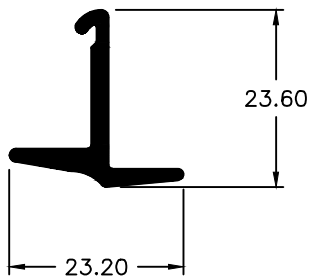

CR-063
Peso: 275 Gr./Mt.

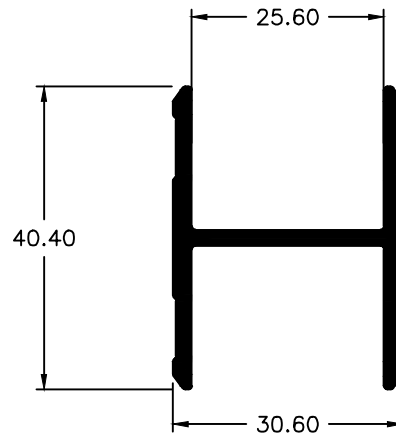

CR-064
Peso: 650 Gr./Mt.

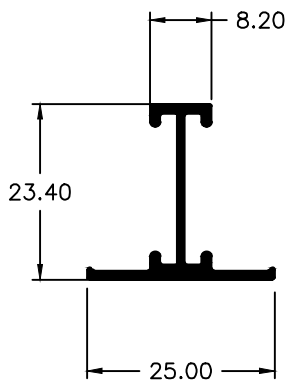

CR-065
Peso: 210 Gr./Mt.

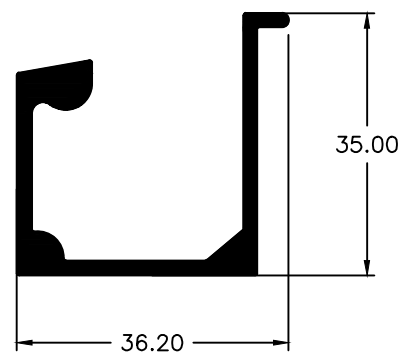

CR-066
Peso: 272 Gr./Mt.

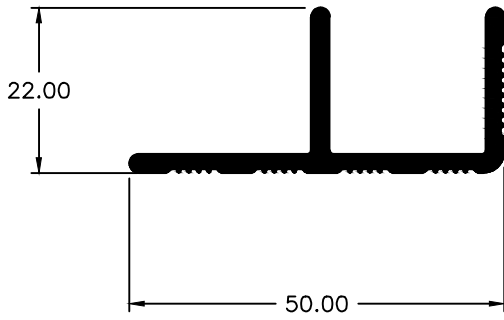

CR-067
Peso: 557 Gr./Mt.

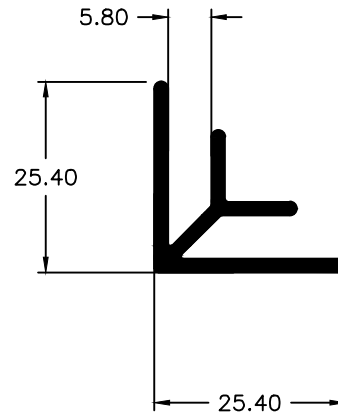

CR-068
Peso: 376 Gr./Mt.

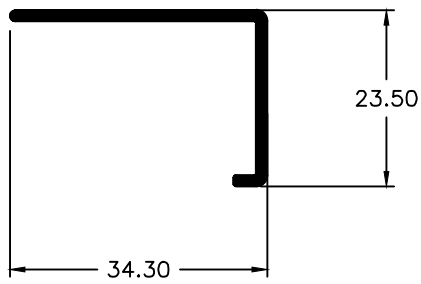

CR-069
Peso: 240 Gr./Mt.

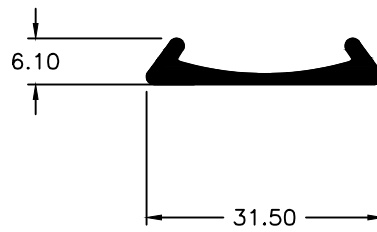

CR-070
Peso: 222 Gr./Mt.

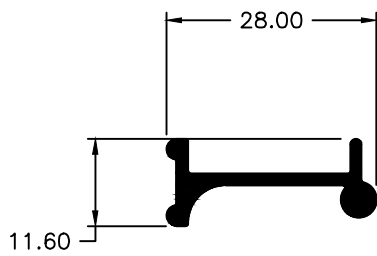

CR-071
Peso: 245 Gr./Mt.

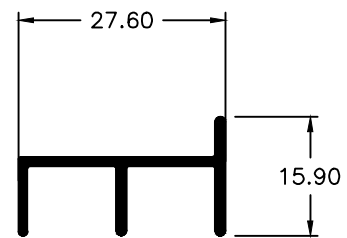

CR-072
Peso: 210 Gr./Mt.

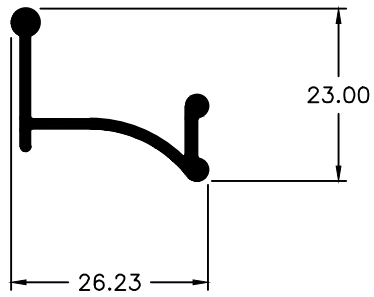

CR-073
Peso: 227 Gr./Mt.

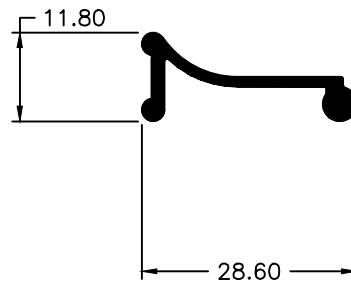

CR-074
Peso: 200 Gr./Mt.

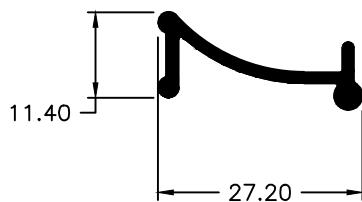

CR-075
Peso: 210 Gr./Mt.

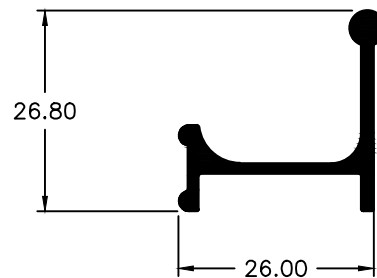

CR-076
Peso: 320 Gr./Mt.

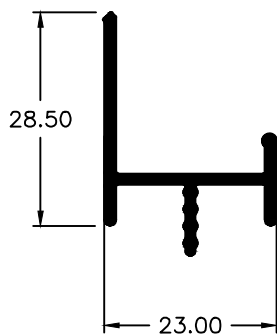

CR-077
Peso: 300 Gr./Mt.

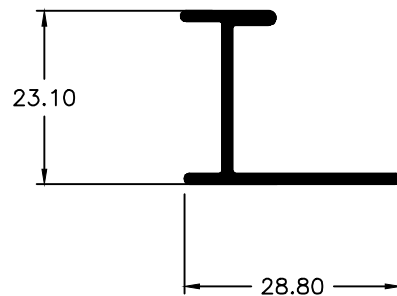

CR-078
Peso: 246 Gr./Mt.

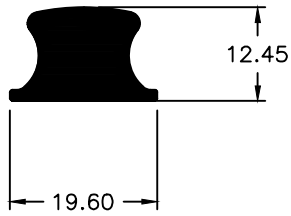

CR-079
Peso: 470 Gr./Mt.

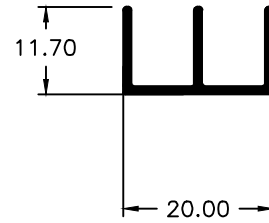

CR-080
Peso: 153 Gr./Mt.

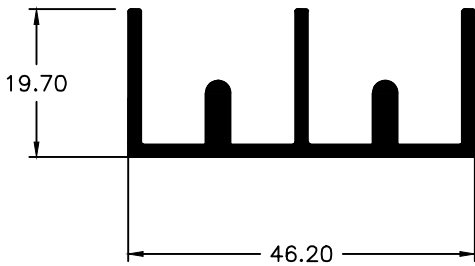

CR-081
Peso: 605 Gr./Mt.

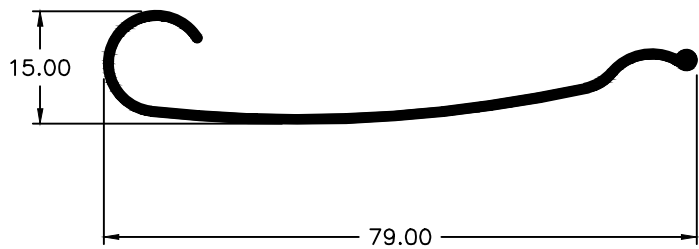

CR-082
Peso: 335 Gr./Mt.

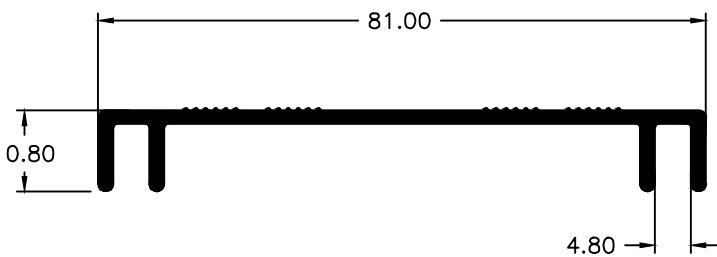

CR-083
Peso: 590 Gr./Mt.

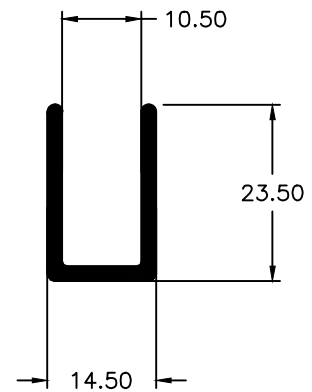

CR-084
Peso: 308 Gr./Mt.

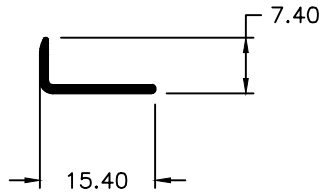

CR-085
Peso: 62 Gr./Mt.

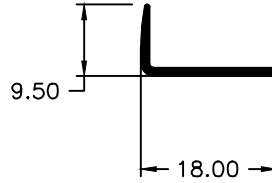

CR-086
Peso: 74 Gr./Mt.

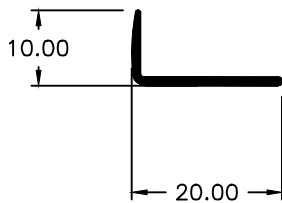

CR-087
Peso: 80 Gr./Mt.

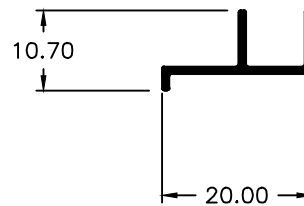

CR-088
Peso: 123 Gr./Mt.

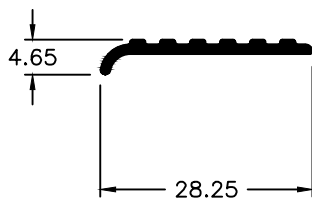

CR-089
Peso: 120 Gr./Mt.

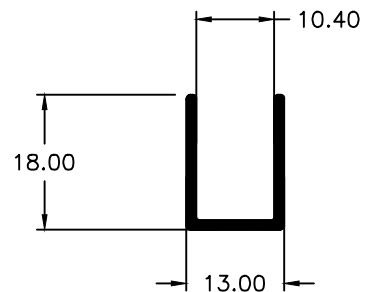

CR-090
Peso: 165 Gr./Mt.

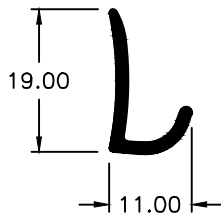

CR - 091
Peso: 134 Gr./Mt.

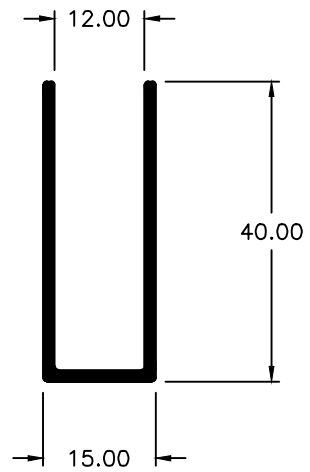

CR - 092
Peso: 380 Gr./Mt.